

SOME ČEBYŠEV SETS WITH DIMENSION $D + 1$ IN HYPERSPACES OVER \mathbb{R}^D

ROBERT J. MACG. DAWSON

*Department of Mathematics and Computing Science,
Saint Mary's University, Halifax,
Nova Scotia, B3H 3C3, Canada
E-mail: rdawson@cs.stmarys.ca*

Abstract. A Čebyšev set in a metric space is one such that every point of the space has a unique nearest neighbour in the set. In Euclidean spaces, this property is equivalent to being closed, convex, and nonempty, but in other spaces classification of Čebyšev sets may be significantly more difficult. In particular, in hyperspaces over normed linear spaces several quite different classes of Čebyšev sets are known, with no unifying description.

Some new families of Čebyšev sets in hyperspaces are exhibited, with dimension $d + 1$ (where d is the dimension of the underlying space). They are constructed as translational closures of appropriate nested arcs.

1. Introduction. For any metric space (X, ρ) , we define a set $A \subset X$ to be a *Čebyšev set* (“be Čebyšev” or “have the Čebyšev property”) if for every $x \in X$ there is a unique nearest point in A . This property has been studied extensively for normed linear spaces. For such spaces, the Čebyšev property is related to convexity. For Minkowski spaces (finite dimensional Banach spaces), every Čebyšev set is convex if balls are smooth, while if the balls are strictly convex, every nonempty closed convex set is Čebyšev [10]. In particular, in Euclidean spaces, the Čebyšev sets are precisely those that are nonempty, closed and convex.

As a generalization of the Čebyšev property, we define A to be *Čebyšev relative to X_0* if every point in X_0 has a unique nearest point in A [6]. This generalizes the concept of “reach”: the reach of a set A can be defined

$$\sup\{r \mid A \text{ is Čebyšev relative to } (A)_r\}$$

2000 *Mathematics Subject Classification*: Primary 52A20; Secondary 41A52.

Key words and phrases: Čebyšev sets, hyperspaces, nested sets, sharply nested

Research supported by an NSERC Discovery Grant

The paper is in final form and no version of it will be published elsewhere.

(where $(A)_r$ is defined in (3) below.)

In this paper, we will consider Čebyšev sets in hyperspaces. A hyperspace \mathcal{H} is a metric space whose points are some class of compact sets in an underlying space $|\mathcal{H}|$. Here, we will assume throughout that $|\mathcal{H}|$ is a Minkowski space (a finite-dimensional Banach space); that \mathcal{H} is closed under Minkowski addition and multiplication by positive scalars; and that the metric is the Hausdorff metric ϱ_H , given by

$$\varrho_H(X, Y) := \max\{\varrho_{\vec{H}}(X, Y), \varrho_{\vec{H}}(Y, X)\}, \quad (1)$$

where the *oriented Hausdorff metric* $\varrho_{\vec{H}}(X, Y)$ is defined by the formula

$$\varrho_{\vec{H}}(X, Y) := \sup_{x \in X} \inf_{y \in Y} \|x - y\| \quad (2)$$

for compact sets X, Y .

If, for $\delta > 0$, we define the δ -parallel body or δ -hull of X as

$$(X)_\delta := X + \delta B, \quad (3)$$

where B is the unit ball, this gives a useful alternative way to consider Hausdorff distance:

$$\varrho_{\vec{H}}(X, Y) = \inf\{\delta \mid X \subseteq (Y)_\delta\}. \quad (4)$$

$$\varrho_H(X, Y) = \inf\{\delta \mid X \subseteq (Y)_\delta \text{ and } Y \subseteq (X)_\delta\}. \quad (5)$$

We are not assuming or defining multiplication by nonpositive scalars, or any inverse operation to Minkowski addition; and it can (though we will not do so here) be shown that except in trivial cases these do not exist in a hyperspace. Creating these formally yields a *Rådström-Hörmander lattice* \mathcal{H}_{RH} , which is a vector space; \mathcal{H} is a cone (not necessarily closed) within it. This is occasionally important as a source of geometric insights. In this paper we will consider the following hyperspaces over the real d -dimensional space.

\mathcal{C}^d : the hyperspace of nonempty compact sets. While a linear structure can be defined on this hyperspace, it is rather weak; in particular, there is no cancellation law for Minkowski addition. An example of a Čebyšev set in \mathcal{C}^d is the set of all singletons; another is of course \mathcal{C}^d itself.

\mathcal{K}^d : the hyperspace of nonempty compact convex sets. In \mathcal{K}^d , the set of all balls and singletons is Čebyšev; this was proved by Bogdewicz and Moszyńska [4], based closely on a result about minimal rings in the plane by Bonnessen [5] and generalized to higher dimensions by Bárány [2]. Other examples in the literature include strictly affine convex sets (necessarily singletons or infinite-dimensional, for $d > 1$)[4] and strongly nested arcs (see below.) The hyperspace \mathcal{K}_0^d of convex bodies is closely related to \mathcal{K}^d , and has similar properties.

\mathcal{O}^d : the hyperspace of strictly convex elements of \mathcal{K}^d ; \mathcal{O}_0^d is defined analogously (and differs from \mathcal{O}^d only in the omission of singletons; all other strictly convex sets are bodies.) It was shown in [6] that families of translates $\{A + x \mid x \in \mathbf{R}^d\}$ are Čebyšev in \mathcal{O}^d . The translations may also be restricted to an arbitrary convex set K of vectors, giving additional finite-dimensional Čebyšev sets $\{A + x \mid x \in K\}$.

\mathcal{Z}^d : the hyperspace of centrally symmetric elements of \mathcal{O}^d ; we will construct Čebyšev sets in this hyperspace in the next section.

These represent hyperspaces over Euclidean spaces. We will occasionally wish to refer to a hyperspace constructed over a space with unit ball B ; this will be represented by (*e.g.*) \mathcal{K}^B .

The concept of a Čebyšev set in a hyperspace is closely related to that of an optimal isometry or translation. For two sets A, X in the hyperspace, an isometry ϕ is *optimal* for the pair (A, X) if $\rho(\phi(A), X) \leq \rho(\phi'(A), X)$ for every ϕ' . Optimal translations (*etc.*) are defined analogously. If one of these is unique, then the class of isometric images (*resp.* translates) of A is Čebyšev .

A *selector* is a function from a hyperspace to its underlying vector space such that $s(A) \in A$. Herburt and Moszyńska [9] define a selector, assumed invariant under Euclidean isometries, to be *associated with* the metric ρ on a hyperspace \mathcal{H} if for $A, X \in \mathcal{H}$, whenever f_0 is optimal for (A, X) with respect to ρ , $s(f_0(A)) = s(B)$. Such a selector is unique up to translation, and hence (as we assume the hyperspace to contain elements of arbitrarily small diameter) unique. Arnold [1] showed that the L_2 metric has the Steiner point as associated selector.

We can define a selector to be *translationally associated with* a metric if it performs the same role for optimal translations. These selectors are also unique; and the existence of such a selector implies that every family $(A + x \mid x \in \mathbf{R}^d)$ is Čebyšev . Note that if the unit ball B is a body with only central symmetry, the concepts of “associated” and “translationally associated” coincide for the hyperspace \mathcal{Z}^B .

In [6], a family of compact sets was defined to be *strongly nested* if it has the property that, for any two distinct elements, one is in the interior of the other. It was shown there that any strongly nested, continuously indexed family $(A_i \mid i \in [0, 1])$ in \mathcal{K}^d is Čebyšev ; indeed, such a family in \mathcal{C}^d is Čebyšev relative to \mathcal{K}^d . This can be extended to families indexed by $[0, \infty)$, provided that $\text{diam}(A_i)$ is unbounded; and in \mathcal{K}_0^d the index set may be open below provided that $\cap A_i$ is a singleton. These classes of Čebyšev sets are “nonparametric” in the sense that, within the class, no finite set of members determines a particular set.

This paper is motivated by the observation that the example of the family of balls and singletons can be thought of as the translational closure of a strongly nested set of strictly convex bodies, thereby combining two ideas each of which gives rise to Čebyšev sets on its own. It is thus natural to investigate other families of this type to look for other Čebyšev sets of dimension $d + 1$.

The most obvious conjectures do not turn out to be true; the translational closure of a strongly nested family is not necessarily Čebyšev in \mathcal{K}^d or even in \mathcal{O}^d ; and even homothetic families are not always Čebyšev in \mathcal{K}^d . However, we exhibit additional conditions that are sufficient to imply the Čebyšev property. In section 2, we show that in the hyperspace \mathcal{Z}^d of centrally symmetric strictly convex bodies the translational closure of a strongly nested family is Čebyšev . In the remaining sections we examine some stricter orderings on \mathcal{K}^d related to the Minkowski sum, and find one such that translational closures of continuous chains are Čebyšev .

2. Čebyšev sets in \mathcal{Z}^d . Our first result concerns \mathcal{Z}^d , the hyperspace consisting of all centrally symmetric elements of \mathcal{O}^d . For any family of bodies \mathcal{A} , let \mathcal{A}^T be the family $\{A + \mathbf{x} \mid A \in \mathcal{A}, \mathbf{x} \in \mathbf{R}^d\}$

LEMMA 2.1. *If A and A' are convex and centrally symmetric with respect to the origin, and $A + x \subset A'$, then also $A \subset A'$.*

Proof: By symmetry, $A - x \subset A'$ also; as A' is convex and contains both $A + x$ and $A - x$, it contains A . ■

OBSERVATION 2.2. : Without the assumption of convexity for at least the larger body, the lemma fails (see Fig. 1.)

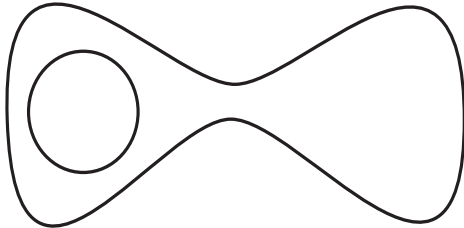

Fig. 1. The smaller body cannot be centered within the larger one.

THEOREM 1. *If $\mathcal{A} = \{A_i \mid i \in [0, 1]\}$ is a continuously indexed, strongly nested family in \mathcal{Z}^d , then \mathcal{A}^T is Čebyšev.*

Proof: Let $X \in \mathcal{Z}^d$, and assume without loss of generality that its center of symmetry is the origin. By Theorem 3.3 of [6], each $A_i \in \mathcal{A}$ has a unique translate $A_i + x_i$ minimizing the Hausdorff distance to X . By Lemma 2.1, if $A_i + x_i \subset (X)_\epsilon$ and $X \subset (A_i)_\epsilon + x_i$, we also have $A_i \subset (X)_\epsilon$ and $X \subset (A_i)_\epsilon$; thus each translate $A_i + x_i$ has the same center of symmetry as X . Another application of the lemma shows that the family of nearest translates is itself strongly nested, and by Theorem 2.8 of [6], it has a unique element minimizing the Hausdorff distance to X . ■

COROLLARY 2.2.1. *The center of symmetry selector is associated with the Hausdorff metric in \mathcal{Z}^d .*

OBSERVATION 2.3. These results hold also in \mathcal{Z}^B whenever the unit ball B is strictly convex; Theorem 2.5 of [3] takes the place of Theorem 3.3 of [6].

REMARK 2.4. I conjecture that a situation such as that in Figure 1 cannot arise within a continuously indexed and strongly nested family. However, convexity is nonetheless essential to the theorem. In Figure 2, the body A consists of two discs of radius 1, with centers 5 units apart, joined by a nonconvex “waist”, while C is a disc of radius 4. The Hausdorff distance between them is minimized when C is centered on one of the “ends” of A .

Moreover, either can be embedded in a nest $(A_t \mid t \in [-1, 1])$ or $(C_t \mid t \in [-1, 1])$ such that no other body in the nest can be translated to so close a fit, as shown to the right. Thus neither family is Čebyšev, and convexity is essential for all bodies involved.

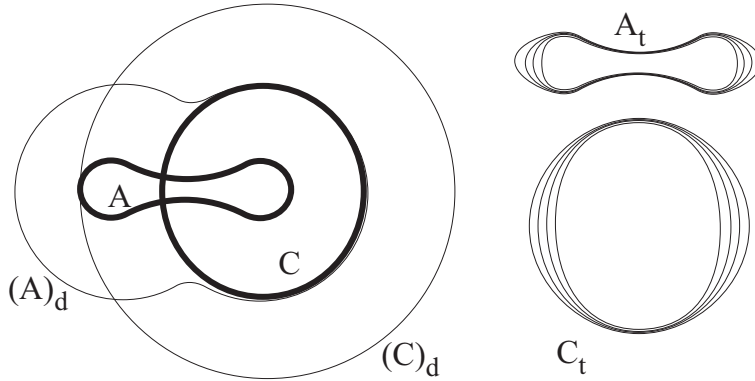

Fig. 2. Counterexample showing that convexity is essential

OBSERVATION 2.5. Theorem 1 and the associated lemma may be generalized to any other symmetry that fixes a unique point (e.g., threefold rotational symmetry in the plane). It does not generalize to other symmetries; for instance, it is not hard to find counterexamples with reflectional symmetry.

3. Stronger nesting conditions. It is not hard to show that the set of translates of a continuously indexed and strongly nested family of bodies, $(A_t + x \mid t \in [0, 1], x \in \mathbf{R}^d)$ is not in general Čebyšev (see, for instance Fig. 3 below). We may consider stronger nesting conditions, such as the additive ordering \ll induced by the Minkowski sum. By definition, $A_i \ll A_j$ whenever A_i is a summand and a subset of A_j ; that is, when there exists some D_j^i containing the origin such that $A_j = A_i + D_j^i$.

The author conjectured in Będlewo in May, 2007 that every nest of bodies in \mathcal{K}_0^d ordered by \ll has the Čebyšev property. In the remainder of this paper we disprove this conjecture, study related ordering properties closely, and prove the result that probably should have been conjectured.

EXAMPLE 3.1. Figure 3a shows a nest of strictly convex bodies (A_i) , all equidistant from a common body X . It may be verified that each of the bodies shown minimizes the distance to X over the set of all of its translates; thus the set $\{A_i + x \mid i \in [0, 1], x \in \mathbf{R}^2\}$ is not Čebyšev. However, it is clear that these bodies form a \ll -chain. Figure 3b shows a typical pair of bodies and their difference body.

Nonetheless, the counterexample does suggest an important principle. The family shown fails to have the Čebyšev property because bodies “of different sizes” can have multiple boundary points in common and thus appear “the same size” to some other body. This leads us to consider the following condition on an ordered pair of sets (A, C) .

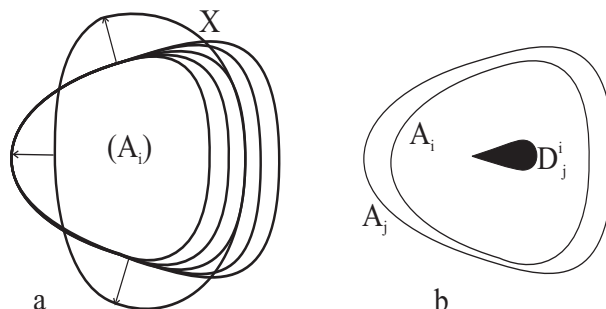

Fig. 3. Counterexample showing that additivity is not sufficient

DEFINITION 3.2. Let $A, C \in \mathcal{K}_0^d$, where $A \subset C$, and let $p \in A \cap \text{bd } C$. We will say A grazes C at p if $p \in A \cap \text{bd } C \subset H$ for some supporting hyperplane H of C .

DEFINITION 3.3. If, for all $c \in \text{bd } C$, there exists a vector x such that $A + x$ grazes C at c , we will write $A \sqsubset C$. (Note that this relation is transitive.) The next proposition shows how this relates to other containment conditions.

PROPOSITION 3.4. If $A \sqsubset C$, then:

- (i). For every $a \in \text{bd } A$ there exists a vector $x(a)$ such that $A + x(a)$ grazes C at $a + x(a)$;
- (ii). A is a summand and a subset of C .

Proof: (i) For $a \in \text{bd } A$, there exists at least one functional f maximized over A at a , which is also maximized over C at at least one point c . By hypothesis there exists $x(c)$ such that $c \in A + x(c) \subset C$ with $A + x(c) \cap \text{bd } C$ contained in a supporting hyperplane H of C ; take $x = x(c)$. But then

$$f(a + x) = \left(\max_{y \in A} f(y) \right) + f(x) \geq f(c - x) + f(x) = f(c)$$

so $a + x \in \text{bd } C$.

(ii) The set $(C \ominus A) + A$ is convex and closed and by hypothesis contains all of $\text{bd } C$ - so it is C . If $A + x \cap \text{bd } C$ is contained in a supporting hyperplane, moving $A + x$ slightly away from the hyperplane brings it into $\text{int } C$, so $C \ominus A \in \mathcal{K}_0^d$. ■

Neither converse holds, and neither of (i) nor (ii) implies the other.

EXAMPLE 3.5. In \mathcal{K}^3 , (i) $\not\Rightarrow$ (ii).

Let A be the “lens” obtained by intersecting the spheres $x^2 + y^2 + (z \pm 0.8)^2 = 1$, and let C be a “North American football” obtained by rotating the arc $x^2 + (y + 3)^2 = 25$, $y \geq 0$, about its chord. These bodies obey (i) but no translate of the lens grazes the football at the “points” of the latter (Figure 4a). Indeed, the points of the football may be rounded to yield a smooth “Rugby football” with similar properties.

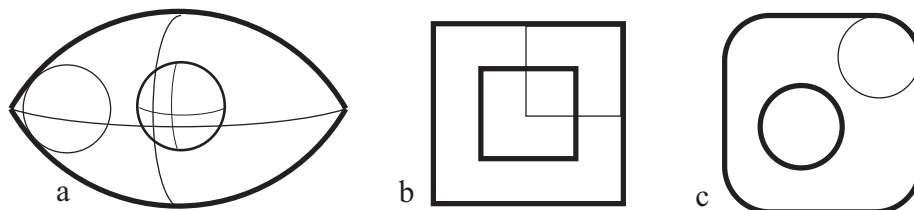

Fig. 4. Examples illustrating non-implications among containment properties

REMARK 3.6. The example above also shows that (i) $\not\Rightarrow (A \sqsubset C)$. However, it seems plausible that (i) and (ii) are equivalent in \mathcal{K}^2 , whereas the following counterexample can be modified to work in any dimension.

EXAMPLE 3.7. (i) $\not\Rightarrow (A \sqsubset C)$.

Let Q_1 be the square with vertices $(\pm 1, \pm 1)$, and $Q_2 = 2Q_1$. Then for a boundary point c of Q_1 , without loss of generality on the edge with vertices $(1, \pm 1)$, $Q_1 + (1, 0)$ grazes Q_2 at $c + (1, 0)$. But no translate of Q_1 fits Q_2 at $(2, 2)$ (Figure 4b).

EXAMPLE 3.8. (ii) $\not\Rightarrow$ (i), $(A \sqsubset C)$.

Let Q be the square with vertices $(\pm 1, \pm 1)$ and A the unit disc; then no translate of A grazes $A + Q$ at the point $(1 + \frac{\sqrt{2}}{2}, 1 + \frac{\sqrt{2}}{2})$ (Figure 4c).

However, with additional conditions on the bodies, we can say more. If $C = A + D$ and D is smooth, write $A \in C$.

PROPOSITION 3.9. $A \in C \Rightarrow A \sqsubset C$.

Proof: Let $A + D = C$. For any $c \in \text{bd } C$, $c = a + d$ for some $a \in \text{bd } A$, $d \in \text{bd } D$. By assumption, D is smooth, so there is a unique f supporting D at d . But then for $c' \in (A + d \cap \text{bd } C)$, f must also support C at c' , and $A \sqsubset C$. ■

PROPOSITION 3.10. *If A is smooth and C is strictly convex, the following are equivalent:*

- (i). *For all $a \in \text{bd } A$ there exists a vector $x(a)$ such that $A + x(a)$ grazes C at $a + x(a)$;*
- (ii). $A \sqsubset C$;
- (iii). $A \in C$.

Proof: (i \Rightarrow ii): If C is strictly convex, then for any $c \in \text{bd } C$ there is a functional f that is maximized over C at c and nowhere else. If A is smooth, f is the unique functional that is maximized over A at some boundary point a . By hypothesis there exists $x(a)$ such that $A + x(a)$ grazes C at $a + x(a)$; but f supports $A + x(a)$ and thus C at $x + a$, so $x + a = c$.

(ii \Rightarrow iii): Let $D = C \ominus A$. If $A \sqsubset C$, then $\text{bd } C \subset D + A \subset C$ and by convexity $D + A = C$. Suppose, for a contradiction, that D is not smooth, *i.e.*, there exist distinct functionals f_1, f_2 that are maximized over D at some point d_0 . These functionals are maximized over A (which is smooth) at distinct points a_1 and a_2 ; and are maximized over C (which is strictly convex) at $a_1 + d_0$ and $a_2 + d_0$ respectively, and nowhere else.

But then the two points $a_1 + d_0$ and $a_2 + d_0$ of $\text{bd } C$ are covered by the same translate of A , but not (by strict convexity) by the same supporting hyperplane, contradicting (ii).

(iii \Rightarrow i): If D is smooth, $A + D$ must be smooth; and if C is strictly convex so are A and D . Thus for each of A, C , and D there is a bijection between boundary points and supporting hyperplanes, and (i) follows. \blacksquare

DEFINITION 3.11. A continuously indexed arc $\mathcal{A} = (A_i \mid i \in I)$ will be called *sharply nested* if $A_i \Subset A_j$ whenever $i < j$; equivalently, there exists a smooth body D_j^i with $A_i + D_j^i = A_j$.

As we are interested only in the translational closure \mathcal{A}^T of this nest, we may assume without loss of generality that the origin is on the interior of D_j^i , so that a sharply nested family is strongly nested. Note that any nonminimal element in a sharply-nested arc must be a smooth body. By Prop. 3.10, any continuous \sqsubset -chain of smooth bodies in \mathcal{O}^n is sharply nested.

4. Lengths of nested arcs.

DEFINITION 4.1. The *length* of an arc $(A_i \mid i \in I)$ is defined to be

$$\sup_{\mathcal{A}} \sum_{n=1}^N \varrho_H(A_{i(n-1)}, A_{i(n)})$$

where the supremum runs over all finite sequences of bodies $\mathcal{A} = (A_{i(0)}, A_{i(1)}, \dots, A_{i(N)})$ with $i(0) < i(1) < \dots < i(N)$. Should the supremum fail to exist we will say the length of the arc is infinite.

PROPOSITION 4.2. *There exists a compact strongly nested arc in \mathcal{K}^2 with infinite length.*

First, we note that between two concentric discs of radius r and R , for any d such that

$$d < R - r \tag{6}$$

we can nest k bodies, each at Hausdorff distance d from the others, provided that

$$\left(1 + \frac{d}{r}\right) < \sec(2\pi/k) \tag{7}$$

as shown in Fig. 5b.

Using the Taylor expansion for a lower bound on the secant, we see that (7) is satisfied if

$$\frac{d}{r} < \frac{2\pi^2}{k^2}. \tag{8}$$

Consider a sequence of concentric discs $(A_n \mid n = 2, 3, \dots)$, with radii $(1 - \frac{1}{n})$ (Fig. 5a). For every $n \geq 3$, we construct a nested sequence of bodies $(A_{n-1,j})$ between A_{n-1} and A_n (Fig. 5b) such that

$$d = \varrho_H(A_{n-1,i-1}, A_{n-1,i}) = \frac{1}{n^2} < \frac{1}{n-1} - \frac{1}{n}.$$

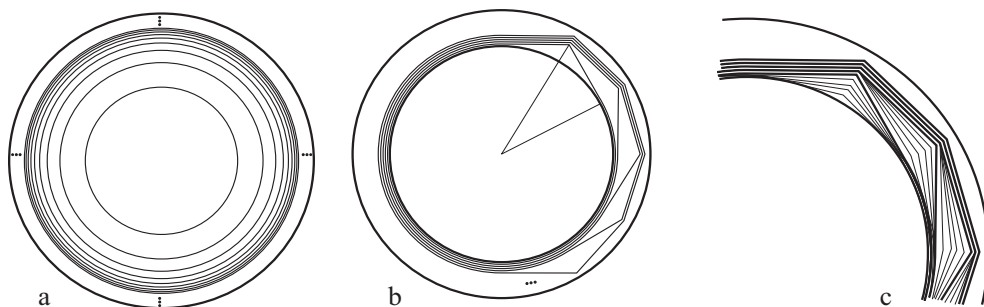

Fig. 5. A \Subset -nested arc with infinite length

(We note that $1/n^2 < 1/(n-1) - 1/n$, so (6) is satisfied.) As the radius of A_{i-1} is always at least $\frac{1}{2}$, (8) gives

$$\frac{d}{r} = \frac{2}{n^2} < \frac{2\pi^2}{k^2}$$

whence the nest can contain $k(n)$ bodies, each at distance at least $\frac{1}{n^2}$ from the others, where

$$k(n) = \lfloor \pi n \rfloor \geq 3n .$$

Finally, we interpolate bodies continuously between A_n and $A_{n,1}$, between $A_{n,j}$ and $A_{n,j+1}$, and between $A_{n,k(n)}$ and A_{n+1} (Fig. 5c); and let A_∞ have radius 1. The arc from A_2 to A_∞ is compact, but is easily verified to have infinite length, as the subarc from A_n to A_{n+1} has an inscribed polygon $A_n A_{n,1} A_{n,2} \cdots A_{n,k(n)} A_{n+1}$ of length at least $3/(n+1)$.

■

REMARK 4.3. This construction does not depend on the dimension (≥ 2) or metric structure of the underlying space, or on the presence of very specific bodies; thus it may be modified for hyperspaces over any Minkowski space of dimension greater than 1.

OBSERVATION 4.4. We recall that analogous situations occur in more familiar spaces. For example, define

$$f(x) := \begin{cases} x \sin(1/x), & \text{if } x \neq 0; \\ 0, & \text{if } x = 0. \end{cases}$$

Then the graph of f for $x \in [0, 1]$ is an ordered arc under the lexicographic ordering of E^2 , but has infinite length (see [8], chapter 10, example 16.)

However, the situation is different for \ll -nested arcs (and hence for \Subset -nested arcs.) While such an arc need not be straight in a metric sense, its length cannot exceed a fixed multiple of its chord length. Recall that, for a compact convex set A , its *mean width* $\bar{b}(A)$ is defined to be

$$\frac{1}{d\omega_d} \int_{S^{d-1}} b(A) ds$$

where $\omega_d = \pi^{n/2}/\Gamma(\frac{n}{2}+1)$ is the volume of the unit d -ball (and $d\omega_d$ the $(d-1)$ -dimensional measure of the unit sphere S^{d-1}), and ds the element of surface measure. In particular,

the mean width (in \mathbf{R}^d , $d > 1$) of a segment of length 1 is

$$\begin{aligned}\bar{b}_d &:= \frac{2(d-1)\omega_{d-1}}{d\omega_d} \int_0^{\pi/2} \cos(\theta) \sin^{d-1}(\theta) d\theta \\ &= \frac{2\Gamma(\frac{d+2}{2})(d-1)}{\Gamma(\frac{d+1}{2})\sqrt{\pi}d^2}\end{aligned}$$

THEOREM 2. *A compact \ll -nested arc in \mathcal{K}_0^d with endpoints A_0, A_1 must have length at most*

$$\frac{\bar{b}(A_1) - \bar{b}(A_0)}{\bar{b}_d}.$$

Proof: Mean width is additive: $\bar{b}(P+Q) = \bar{b}(P) + \bar{b}(Q)$. If $A \in C$, then by definition $C = A + D$ for some smooth body D containing the origin. It follows that $\varrho_H(A, C) = \bar{\varrho}_H(C, A) = r_{\max}$, the radius of the smallest disc centered at the origin containing D . There exists a segment R of length r_{\max} , with one endpoint at the origin, contained in D . Then:

$$\begin{aligned}\bar{b}(A+D) &> \bar{b}(A+R) \\ &= \bar{b}(A) + \bar{b}(R) \\ &= \bar{b}(A) + r_{\max}\bar{b}_d.\end{aligned}$$

Thus

$$\varrho_H(A, C) = r_{\max} < \frac{\bar{b}(C) - \bar{b}(A)}{\bar{b}_d}.$$

If we apply this to any finite subset $\mathcal{A} = (A_{i(0)} \ll A_{i(1)} \ll \dots \ll A_{i(N(\mathcal{A}))})$ of a \ll -nested arc, we find that

$$\begin{aligned}\sum_{n=1}^{N(\mathcal{A})} \varrho_H(A_{i(n-1)}, A_{i(n)}) &< \sum_{n=1}^{N(\mathcal{A})} \frac{\bar{b}(A_{i(n-1)}) - \bar{b}(A_{i(n)})}{\bar{b}_d} \\ &= \frac{\bar{b}(A_{i(N(\mathcal{A}))}) - \bar{b}(A_{i(0)})}{\bar{b}_d}.\end{aligned}$$

It follows that

$$\sup_{\mathcal{A}} \sum_{n=1}^{N(\mathcal{A})} \varrho_H(A_{i(n-1)}, A_{i(n)}) \leq \frac{\bar{b}(A_1) - \bar{b}(A_0)}{\bar{b}_d}$$

which was the desired bound. ■

OBSERVATION 4.5. In \mathcal{K}^2 , if we consider arcs of the form $(A + tD \mid t \in [0, 1])$ where D is an ellipse of very high eccentricity with the origin at one focus, we see that the bound achieved above is the best possible.

OBSERVATION 4.6. It is perhaps more natural to ask how the arc length relates to the Hausdorff distance between the endpoints. As the difference in mean width between two bodies is less than or equal to twice their Hausdorff distance, the length L of a compact

sharply nested arc in \mathcal{K}^d with endpoints A_0, A_1 must satisfy

$$L \leq \frac{2\rho_H(A_0, A_1)}{\bar{b}_d}.$$

This latter bound, however, does not appear ever to be optimal. It is an open problem to determine optimal bounds, either for the general case or for specific endpoints.

EXAMPLE 4.7. We have $\bar{b}_2 = 2\Gamma(2)/(4\Gamma(\frac{3}{2})\sqrt{\pi}) = \frac{1}{\pi}$; thus in \mathcal{K}^2 , Hausdorff arc length cannot exceed $\pi(\bar{b}(A_1) - \bar{b}(A_0))$, which in turn cannot exceed $2\pi\rho_H(A_0, A_1)$.

OBSERVATION 4.8. There is again an analogous situation in E^2 . Consider any arc whose points (in Cartesian coordinates) are ordered with the product ordering (in which $(x, y) < (x', y')$ if $x < x'$ and $y < y'$.) Such an arc is not in general a metric segment, but if the endpoints are P and Q , the arc length must be strictly less than $\sqrt{2}d(P, Q)$.

5. Translational closures of sharply nested arcs. We shall show that, subject to certain conditions, if \mathcal{A} is sharply nested in $\mathcal{K}^2, \mathcal{K}_0^2, \mathcal{O}^2$, or \mathcal{O}^2 , then \mathcal{A}^T is Čebyšev. Note that the results of this section, while stated for hyperspaces over Euclidean spaces, use no special properties of the Euclidean metric except for the strict convexity of balls; they are therefore also valid in hyperspaces over any other two-dimensional Minkowski space in which the balls are strictly convex.

LEMMA 5.1. *A strongly nested arc $(A_i \mid i \in I)$ in a hyperspace \mathcal{H} is closed if both of the following conditions are satisfied:*

- i. *if I is open above, then $\cup_{i \in I} A_i \notin \mathcal{H}$;*
- ii. *if I is open below, then $\cap_{i \in I} A_i \notin \mathcal{H}$.*

In particular, $(A_i \mid i \in [a, b])$ is closed in any of the hyperspaces we have considered, and $(A_i \mid i \in [a, b))$ is closed if the arc is unbounded. Moreover, $(A_i \mid i \in (a, b])$ is closed in \mathcal{K}_0^n or \mathcal{O}_0^n if $\cap_{i \in I} A_i$ is a singleton, though it is never closed in \mathcal{K}^n or \mathcal{O}^n because of the missing lower bound. Again, an arc in \mathcal{O}^n , indexed by an open or half-open I , may be closed if its intersection and/or union are not strictly convex.

For a fixed compact convex X and a strongly nested arc $(A_i : i \in I)$, let

$$\rho = \inf_{i \in I, s \in \mathbf{R}^d} \rho_H(A_i + s, X).$$

LEMMA 5.2. *If a strongly nested arc $(A_i \mid i \in I)$ is closed in \mathcal{H} , then for any $X \in \mathcal{H}$, $\{A_i + s \mid \rho_H(A_i + s, X) = \rho\}$ is nonempty and compact.*

Proof: This follows immediately from the continuity of the functions involved. ■

We can thus define A_m to be the smallest element of \mathcal{A} with a translate at minimal distance from X ; without loss of generality, we may assume A_m itself to be such a translate. The following is true for \mathcal{K}^d and \mathcal{O}^d (and vacuously true for \mathcal{K}_0^d and \mathcal{O}_0^d .)

LEMMA 5.3. *If X is not a singleton, neither is A_m .*

Proof: The distance $\rho_H(X, \{a\})$ is minimized over all $a \in \mathbf{R}^d$ when a is the Čebyšev point of X , $\check{c}X$; this is always within X (see [4]). But then $\rho_{\vec{H}}(\{\check{c}(X)\}, X) = 0$, and by

continuity there exists a body $A_i + \check{c}(X)$, $i > 0$, which is contained in a ball of radius less than $\rho/2$ about $\check{c}(X)$ and contains a ball of radius ϵ about the same point. Therefore, $\varrho_{\vec{H}}(A_i + \check{c}(X), X) < \rho/2$ while $\varrho_{\vec{H}}(X, A_i + \check{c}(X)) < \rho - \epsilon$; thus $A_i + \check{c}(X)$ is closer to X than any singleton. ■

DEFINITION 5.4. $\Delta := (X)_\rho \ominus A_m$; and $\nabla := -((A_m)_\rho \ominus X)$. That is, Δ is the set of vectors by which we may translate A_m while keeping $\varrho_{\vec{H}}(A_m, X) \leq \rho$, while ∇ is the set of vectors by which we may translate A_m while keeping $\varrho_{\vec{H}}(X, A_m) \leq \rho$.

PROPOSITION 5.5. *Suppose that a strongly nested arc $(A_i \mid i \in I)$ is unbounded and $\cap_{i \in I} A_i$ is a singleton; then both $\Delta \cap \text{int } \nabla$ and $\nabla \cap \text{int } \Delta$ are empty.*

Proof: We first note that if X is a singleton in \mathcal{K}^d , then $A_m = A_0$ which is also a singleton, as are both Δ and ∇ , and the result is trivial. Suppose that X is not a singleton, and let $t \in \Delta \cap \text{int } \nabla$. Then $X \subset \text{int } (A_m + t)_\rho$, and there exists $\epsilon > 0$ such that $X \subset \text{int } (A_m + t)_{\rho - \epsilon}$. By Lemma 5.3, $m > 0$; so let $A_k \subsetneq A_m$ with $(A_k)_\delta \subset A_m \subset (A_k)_\epsilon$ for some $\delta > 0$; then

$$X \subset \text{int } (A_k + t)_\rho. \quad (9)$$

But we also have $(A_k + t)_\delta \subset A_m + t \subset (X)_\rho$, so

$$A_k + t \subset \text{int } (X)_\rho. \quad (10)$$

It follows that there is a smaller d that leaves both (9) and (10) satisfied, again contradicting our definition of d as the minimal distance and proving $\Delta \cap \text{int } \nabla$ to be empty. The proof that $\nabla \cap \text{int } \Delta$ is empty is similar, but substitutes a larger nest element rather than a smaller one to obtain the contradiction. ■

COROLLARY 5.5.1. *0 is on the boundaries of both Δ and ∇ .*

Proof: Obviously, $0 \in \Delta \cap \nabla$; but, by Prop. 5.5, it cannot be in the interior of either set. ■

The next result, which is essentially planar, shows that no other translate of A_m can come as close to X as A_m itself does.

PROPOSITION 5.6. *Suppose that a strongly nested arc $(A_i \mid i \in I)$ in \mathcal{K}^2 or \mathcal{K}_0^2 is unbounded, and $\cap_{i \in I} A_i$ is a singleton. Then $\Delta \cap \nabla = \{0\}$.*

Proof: We have shown that neither Δ nor ∇ intersects the interior of the other. By Proposition 5.5, if their intersection is not a singleton, it is a line segment ℓ , containing the origin, and of length $L > 0$. Let $\{x \mid f(x) = 0\} = \text{aff } \ell$; by the same proposition, without loss of generality, $\max_{x \in \Delta} f(x) = 0$. Moreover, $\min_{x \in \nabla} f(x) = \max_{x \in -\nabla} f(x) = 0$.

For any compact convex set K , define $L(K)$ to be the linear measure of $\{k \mid f(k) = \max_{x \in K} f_L(x)\}$. Clearly $L(K + M) = L(K) + L(M)$; and as balls are strictly convex, $L((K)_d) = L(K)$. Moreover, if $L(K \ominus M) > 0$, then $L(K) = L(M) + L(K \ominus M)$. Both $L(\Delta)$ and $L(-\nabla)$ are greater than or equal to L .

But this leads to a contradiction, for

$$L(X) = L((X)_\rho) = L(A_m) + L(\Delta) \geq L(A_m) + L \tag{11}$$

but

$$L(A_m) = L((A_m)_\rho) = L(X) + L(-\nabla) \geq L(X) + L \tag{12}$$

so we conclude that the intersection is a singleton. ■

As an immediate corollary, we get the following result.

THEOREM 3. *Suppose that a strongly nested arc $(A_i \mid i \in I)$ in \mathcal{K}^2 or \mathcal{K}_0^2 is unbounded, and $\cap_{i \in I} A_i$ is a singleton. Then the minimal distance from a compact convex X to \mathcal{A}^T cannot be achieved by two translates of the same A_m .*

REMARK 5.7. For the hyperspace \mathcal{O}^d of strictly convex bodies, the uniqueness of closest translates was proved, with no assumptions about nesting, as Theorem 3.3 of [6].

EXAMPLE 5.8. Without strict convexity, Theorem 3 cannot be extended to \mathcal{K}^d or \mathcal{K}_0^d for $d > 2$. Let

$$X := \text{conv} \{(\pm 1, \pm 1, \pm 1), (0, 0, \pm 2)\}; \tag{13}$$

$$P = \text{conv} \{(\pm 0.9, \pm 0.9, \pm 0.9), (0, \pm 1.9, 0)\}; \tag{14}$$

and

$$A_\lambda = \lambda((P)_{0.1}) \tag{15}$$

(see Figure 6)

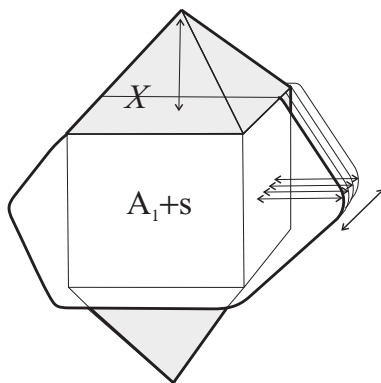

Fig. 6. Strict convexity is necessary in more than two dimensions.

Then $\varrho_H^{\vec{r}}(X, A_\lambda + s) \geq 2 - \lambda$ with equality only if $s_2 = 0$, while $\varrho_H^{\vec{r}}(A_\lambda + s, X) \geq 2\lambda - 1$ with equality only if $s_3 = 0$. The maximum of the two distances is always greater than or equal to 1, and this can only be attained for $s_2 = s_3 = 0, \lambda = 1$. However, this minimum distance may be achieved for any $s = (s_1, 0, 0)$, with $s_1 < 0.5$; so the family is not Čebyšev. Note that the family A_λ is \mathbb{E} -ordered.

The requirement that the smallest element, if any, be a singleton is essential.

PROPOSITION 5.9. *In \mathcal{K}^2 or \mathcal{K}_0^2 , if a nested family \mathcal{A} has a nonsingleton smallest element A_0 , then there exists a body X equidistant from multiple translates of A_0 and more distant from any translate of any other A_i .*

Proof: The body X is constructed from A_0 as in Prop. 3.5 of [6] (see Figure 7), by truncating normal to a line joining two points at maximum distance. ■

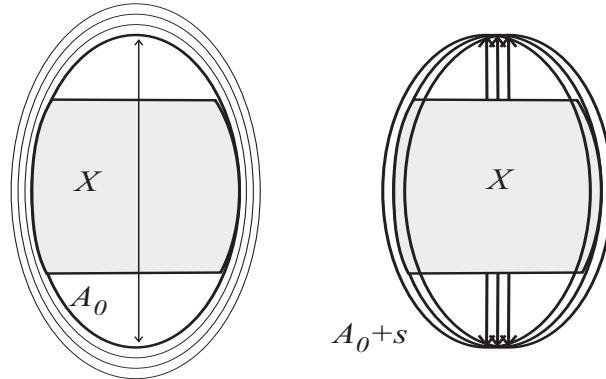

Fig. 7. A body equidistant from various translates of A_0

PROPOSITION 5.10. *Suppose \mathcal{A} in \mathcal{K}^2 is strongly nested and continuously indexed by $[0, 1]$, $\text{int } \Delta = \emptyset$, A_0 is a singleton, and A_1 is strictly convex. Then the minimal distance from a compact convex X to \mathcal{A}^T cannot be achieved by two translates of the same A_m .*

Proof: If $m < 1$ this proceeds as above. If $m = 1$, if we had $\varrho_{\vec{H}}(X, A_1 + s) < \rho$ for any s , we could find $\epsilon > 0$ such that $\varrho_{\vec{H}}(X, A_{1-\epsilon} + s) < \rho$ and $\varrho_{\vec{H}}(A_{1-\epsilon} + s, X) < \rho$, a contradiction. Thus we conclude that

$$\varrho_{\vec{H}}(X, A_1 + s) \geq \rho \quad (16)$$

for every s .

By assumption we have equality for $s = 0$; suppose we have it for another s as well. Then $X \subset (A_1)_\rho \cap (A_m + s)_\rho = (A_1)_\rho \cap ((A_1)_\rho + s)$. Suppose $x \in X$; then $x, x - s \in (A_1)_\rho$, and by strict convexity $x - s/2 \in \text{int } (A_1)_\rho$. It follows that $X \subset \text{int } (A_1 + s/2)_\rho$, and by compactness $\varrho_{\vec{H}}(X, A_1 + s/2) < \rho$, contradicting (16). ■

OBSERVATION 5.11. Interchanging the roles of the bodies in Figure 7 shows that we cannot entirely drop the strict convexity requirement on the largest body. (A similar observation was made in [6].) However, some relaxation is possible; for instance, a “D-shaped” largest body will work.

OBSERVATION 5.12. This proposition uses the assumption that the Minkowski space is strictly convex; the reader may verify, using an example similar to that in Figure 7, that this assumption cannot be dropped.

We now consider the question of when translates of two different bodies in a sharply nested family can both attain the minimal distance (recall that we have chosen A_m so that no smaller body does so.) Let $P := A_m \cap \text{bd } (X)_\rho$, and $Q := X \cap \text{bd } (A_m)_\rho$. For any smooth body K and any $x \in \text{bd } K$, let $n_K(x)$ be the outward-directed unit normal vector to K at x . Define $M := \{n_{(X)_\rho}(p) \mid p \in P\}$, and $N := \{n_{(A_m)_\rho}(q) \mid q \in Q\}$.

LEMMA 5.13. *For $X \in \mathcal{K}^n$ and $(A_i \mid i \in I)$ strongly nested and unbounded in \mathcal{K}^n , let $A_m, P, Q, M,$ and N be as defined above; then M and N are nonempty, closed and disjoint.*

Proof: Closure follows immediately from the definition.

If (for instance) M were empty, this would imply that $P = \emptyset$ and $\varrho_{\vec{H}}(A_m, X) < \rho$; replacing A_m by a slightly larger A_j would make both $\varrho_{\vec{H}}(A_j, X)$ and $\varrho_{\vec{H}}(X, A_j)$ less than ρ , a contradiction. The proof for N is more or less identical.

If a vector u were common to M and N , we would have (X and A_m being convex):

$$\max_{a \in A_m} u \cdot a = \max_{x \in (X)_\rho} u \cdot x = \max_{x \in X} u \cdot x + \rho$$

but also

$$\max_{x \in X} u \cdot x = \max_{a \in (A_m)_\rho} u \cdot a = \max_{a \in (A_m)} u \cdot a + \rho$$

which is impossible. ■

Our goal is to examine the structure of $M, N, \Delta,$ and ∇ , when $(A_i \mid i \in I)$ is sharply nested in the plane. We will show that some configurations would imply the existence of a body $A_j + s$ that was closer to X , and are thus impossible under our supposition that A_m is at minimal distance. With the remaining configurations, however, no other body $A_j + s$ can be as close.

LEMMA 5.14. *Let $X, (A_i), \rho$ and m be as defined above, with (A_i) sharply nested. Then if $\varrho_{\vec{H}}(A_j + s, X) = \rho, D_j^m + s \subset \Delta,$ but $D_j^m + s \not\subset \text{int } \Delta.$*

Proof: If $\varrho_{\vec{H}}(A_j + s, X) = \rho$, then $A_j + s \subset (X)_\rho$ and $D_j^m + s \subset \Delta$. However, if $D_j^m + s \subset \text{int } \Delta$, then $A_j + s \subset \text{int } (X)_\rho$ and $\varrho_{\vec{H}}(A_j + s, X) < \rho$. ■

COROLLARY 5.14.1. *Let $X, (A_i),$ and ρ be as defined above, with (A_i) sharply nested. If $\varrho_{\vec{H}}(A_j + s, X) = \rho$ for some $j > m,$ then $\text{int } \Delta \neq \emptyset.$*

LEMMA 5.15. *The hyperplanes $\{x \mid n \cdot x = 0\}, n \in M,$ support Δ at 0; and the hyperplanes $\{x \mid n \cdot x = 0\}, n \in N,$ support ∇ at 0.*

The next proposition allows us to deduce the short-range mobility of A_m within $(X)_d$ from local conditions. It has some resemblance to lemmas 1.2 and 1.3 of [7].

PROPOSITION 5.16. *Given a smooth compact convex set $C \in \mathcal{K}^d, d > 0,$ and a compact set $A \subset C,$ let $\Delta := C \ominus A$ and $P := A \cap \text{bd } C.$ For $y \in \mathbf{R}^d,$ there exists $\lambda > 0$ with $\lambda y \in \text{int } \Delta$ if and only if $y \cdot n_C(p) < 0$ for all $p \in P.$*

Proof: Clearly if $y \cdot n_C(p) \geq 0$, for all $\lambda > 0$ we have $p + \lambda y \notin \text{int } C$, hence $A + \lambda y \not\subset C$ and $\lambda y \notin \Delta$.

We now prove the converse. Suppose for some $p,$

$$y \cdot n_C(p) < 0. \tag{17}$$

Let

$$a := \frac{-y \cdot n_C(p)}{\|y\|} . \quad (18)$$

As C is smooth, there exists $\epsilon > 0$ such that for $b \in (\text{bd } C) \cap B(p, \epsilon)$ we have both

$$\frac{|n_C(p) \cdot (b - p)|}{\|b - p\|} \leq a/4 \quad (19)$$

and

$$\|n_C(b) - n_C(p)\| \leq a/4 . \quad (20)$$

If we select any λ satisfying

$$0 < \lambda < \frac{\epsilon}{2\|y\|} \quad (21)$$

define b to be any point in $\text{bd } (X)_d$ at minimal distance from $p + \lambda y$. Then

$$d(b, p + \lambda y) \leq d(p, p + \lambda y) = \lambda\|y\| \quad (22)$$

and

$$\|b - p\| \leq 2\lambda\|y\| < \epsilon , \quad (23)$$

so that b satisfies both (19) and (20).

From (19) and (23) we obtain

$$|n_C(p) \cdot (b - p)| < \frac{a}{4}\|b - p\| < \frac{a}{2}\lambda\|y\| . \quad (24)$$

Combining (20) and (22) we also get

$$|(n_C(b) - n_C(p)) \cdot (b - p - \lambda y)| \leq \frac{a}{4}\lambda\|y\| . \quad (25)$$

As $n_C(b)$ is a unit normal vector to C at b , the distance from $p + \lambda y$ to b (and hence, by definition, to the complement of C is given by

$$|b - p - \lambda y| = n_C(b) \cdot (b - p - \lambda y) . \quad (26)$$

But

$$n_C(b) \cdot (b - p - \lambda y) = (n_C(b) - n_C(p)) \cdot (b - p - \lambda y) + n_C(p) \cdot (b - p) - n_C(p) \cdot \lambda y . \quad (27)$$

Substituting (25), (24), and (18) respectively into the right-hand side of (27), and using the triangle inequality, we get

$$n_C(b) \cdot (b - p - \lambda y) \geq \frac{a}{4}\lambda\|y\| > 0 \quad (28)$$

Thus, for any y satisfying (17) for $p \in P$, and any λ satisfying (21), $p + \lambda y \in \text{int } C$.

But, by our original assumption, y satisfies (17) for every $p \in P$. Moreover, if a is a point of A not in P , it may be translated some distance in any direction while remaining in $\text{int } C$. So, for this fixed y and any $a \in A$, there exists $\lambda(a) > 0$ such that for $0 < \lambda < \lambda(a)$ we have $a + \lambda y \in \text{int } C$. This may be chosen continuously as a function of a . Define $\lambda_{\min} := \min_{a \in A} \lambda(a)$; this is positive by the compactness of A , and $\lambda_{\min} y \in \text{int } \Delta$. ■

PROPOSITION 5.17. *Given a sharply-nested family \mathcal{A} in \mathcal{K}^2 , with A_m minimizing the Hausdorff distance to some X over \mathcal{A}^T , and with Δ , ∇ , M , and N as above, some line of N^\perp does not intersect $\text{int } \Delta$.*

Proof: We note first that the elements of M must lie within an angle less than 180° , as otherwise $\text{int } \Delta$ would be empty. It follows that there exist $m_0, m_1 \in M$ such that every other element of M is of the form $a_0 m_0 + a_1 m_1$ for $a_0, a_1 > 0$.

Let $\overrightarrow{0u_0} = \{x \mid x \cdot m_0 = 0, x \cdot m_1 \leq 0\}$ and $\overrightarrow{0u_1} = \{x \mid x \cdot m_1 = 0, x \cdot m_0 \leq 0\}$. By Proposition 5.16 no point on these rays is in $\text{int } \Delta$. However, for $p \in \overrightarrow{0u_0}$ and any $\epsilon > 0$ there exists $q \in B(p, \epsilon)$ such that $q \cdot m_0 < 0$ and $q \cdot m_1 < 0$, so that for some $\lambda > 0$, $\lambda q \in \text{int } \Delta$. The same is obviously true for $\overrightarrow{0u_1}$; thus these rays are the limits of sequences of rays intersecting $\text{int } \Delta$.

Suppose now that every line of N^\perp does intersect $\text{int } \Delta$. Intersecting each of these lines with the halfplane $\{x \mid m_0 \cdot x \leq 0\}$ gives a ray $\overrightarrow{0v}$ with $v \in \Delta$. This set of rays is linearly ordered and (Lemma 5.13) closed, so it has first and last elements $\overrightarrow{0v_0}$ and $\overrightarrow{0v_1}$.

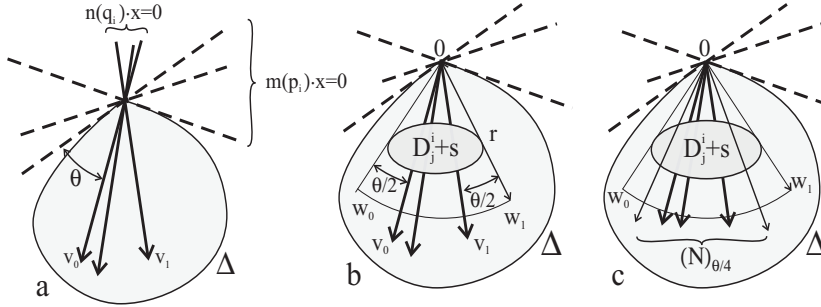

Fig. 8. The case in which every line of N^\perp intersects $\text{int } \Delta$

Because M and N are closed and disjoint, there is a positive angular separation between them in S^1 , let us say θ (see Figure 8a). We define $\overrightarrow{0w_0}$ to be the ray making an angle of $\theta/2$ with $\overrightarrow{0v_0}$ on the opposite side from $\overrightarrow{0v_1}$, and $\overrightarrow{0w_1}$ to be the ray making an angle of $\theta/2$ with $\overrightarrow{0v_1}$ on the opposite side from $\overrightarrow{0v_0}$ (Figure 8b). As all of these rays intersect $\text{int } \Delta$ and represent a closed set in S^1 , there exists $r > 0$ such that for every $\overrightarrow{0x}$ lying between $\overrightarrow{0w_0}$ and $\overrightarrow{0w_1}$, we have $\overrightarrow{0x} \cap B(0, r) \subset \text{int } \Delta$. Let S be the circular sector obtained as the union of these segments.

By taking j greater than but close enough to m , we may make the diameter of D_j^m arbitrarily small, so that $S \ominus D_j^m \neq \emptyset$. For any $s \in (S \ominus D_j^m)$ we have

$$D_j^m + s \subset \text{int } \Delta \quad . \quad (29)$$

From this last, we get

$$A_j + s = A_m + D_j^m + s \subset \text{int } A_m + \Delta \subset \text{int } (X)_\rho \quad . \quad (30)$$

from which it follows immediately that

$$\varrho_{\vec{H}}(A_j + s, X) < \varrho_{\vec{H}}(A_m, X) \quad . \quad (31)$$

Proving that the other directed distance is also reduced is a little more difficult; the problem is that while A_j contains A_m , $A_j + s$ does not necessarily do so, so that some points in X may be further from $A_j + s$ than they are from A_m . However, we will show

that the points at which this happens are bounded away from Q , so that they are not the points at which the maximum distance is achieved.

As D_j^m is smooth and S is not smooth at 0 , $0 \notin S \ominus D_j^m$. But $S \ominus D_j^m$ is compact, so the infimum of the norm over $S \ominus D_j^m$ is positive, and is achieved at some vector s . Evidently $D_j^m + s$ intersects both $\overrightarrow{0w_0}$ and $\overrightarrow{0w_1}$.

Define $(N)_{\theta/4}$ to be the set of unit vectors making an angle of $\theta/4$ or less with some vector in N . It is clear that not only every line in N^\perp but every line in $(N)_{\theta/4}^\perp$ intersects $\text{int}(D_j^m + s)$, and so

$$(\forall n \in (N)_{\theta/4})(\exists x \in D_j^m + s)(n \cdot x > 0) \quad . \quad (32)$$

It follows that

$$(\forall n \in (N)_{\theta/4})(\max_{y \in A_j + s} n \cdot y > \max_{y \in A_m} n \cdot y) \quad . \quad (33)$$

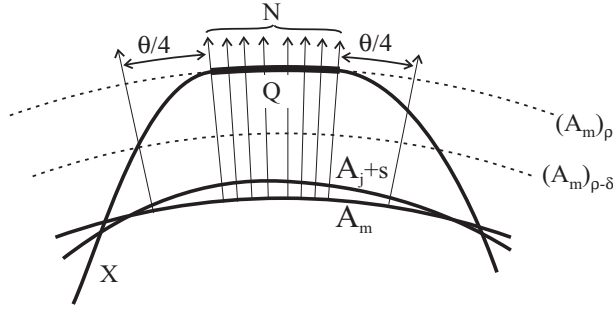

Fig. 9. The configuration near Q

Let $\xi_{A_m} : (\mathbf{R}^2 \setminus A_m) \rightarrow \text{bd } A_m$ be the metric projection (“nearest neighbour”) map, and let $n_{A_m} : \text{bd } A_m \rightarrow S^1$ be the normal map. These are both continuous, whence so is the composite $n_{A_m} \xi_{A_m}$; note that for x outside of A_m ,

$$n_{A_m} \xi_{A_m} x = \frac{x - \xi(x)}{\|x - \xi(x)\|} \quad (34)$$

Moreover, $n_{A_m} \xi_{A_m} Q = N$; so

$$(\exists \epsilon > 0)(n_{A_m} \xi_{A_m}(Q)_\epsilon \subset (N)_{\theta/4}) \quad . \quad (35)$$

But the function $x \mapsto \vec{\rho}_H(x, A_m)$ is Lipschitz; so

$$(\exists \delta > 0)(\forall x \in X)(d - \vec{\rho}_H(x, A_m) < \delta \Rightarrow x \in (Q)_\epsilon) \quad (36)$$

(we may put the quantifiers in this order because X is compact.) Combining (34-36) we conclude that there exists $\delta > 0$ such that for $x \in X$,

$$x \in (A_m)_{\rho-\delta} \text{ or } \frac{x - \xi_{A_m}(x)}{\|x - \xi_{A_m}(x)\|} \in (N)_{\theta/4} \quad (37)$$

If now we select $D_j^m + s$ to lie within $\delta/2$ of the origin, while touching both bounding radii of the sector S , then for every point $x \in X$, one of the two alternatives given by (37) holds. If $x \in (A_m)_{\rho-\delta}$, then $x \in (A_j + s)_{\rho-\delta/2}$. Otherwise, the line $\{y \mid y \cdot (x - \xi_{A_m}(x))\}$ of $(N)_{\theta/4}^\perp$ intersects the interior of $D_j^m + s$, $\xi_{A_m}(x)$ is an interior point of $A_j + s$, and we

conclude again that the distance from $A_j + s$ to x is less than ρ . By the compactness of $(N)_{\theta/4}$ we conclude that

$$\varrho_{\vec{H}}(X, A_j + s) < \varrho_{\vec{H}}(X, A_m) \quad (38)$$

which in combination with (31) contradicts our assumption that A_m was at minimal Hausdorff distance from X among all elements of \mathcal{A}^T . ■

PROPOSITION 5.18. *Given a sharply-nested family \mathcal{A} in \mathcal{K}^2 , and a compact convex set X , the minimum Hausdorff distance from X to \mathcal{A}^T cannot be attained by translates of two distinct nest elements A_m and A_j .*

Proof: If A_m is at minimal distance d from X , and no smaller nest element has an equally close translate, then by Prop. 5.17, the set N^\perp contains a line $\ell_n := \{x \mid n \cdot x = 0\}$ which does not intersect $\text{int } \Delta$ except at 0. (Recall that $n = n(q)$ for some $q \in Q = X \cap (A_m)_\rho$.)

This line cannot contain other boundary points of Δ because (as shown in the proof of Prop. 5.17) the lines bounding the cone generated by Δ are in M^\perp , and by Lemma 5.13 M and N are disjoint. Note that Δ cannot be smooth at 0, as then M^\perp , nonempty by Lemma 5.13, would have to contain the unique tangent line (see Fig. 10a). This would force all lines of N^\perp (which is again nonempty) to intersect $\text{int } \Delta$.

Consider now any body $A_j + s$ with $j > i$. By supposition, $D_j^m + s$ is smooth; and by Lemma 5.14 it must be a subset of Δ . Thus $D_j^m + s$ cannot contain 0, (Fig. 10b) and thus has empty intersection with ℓ_n . It follows that

$$\max_{a \in A_j + s} a \cdot n < \max_{a \in A_m} a \cdot n = (q \cdot n) - \rho \quad (39)$$

so that $\varrho_{\vec{H}}(q, A_j + s) > \rho$. ■

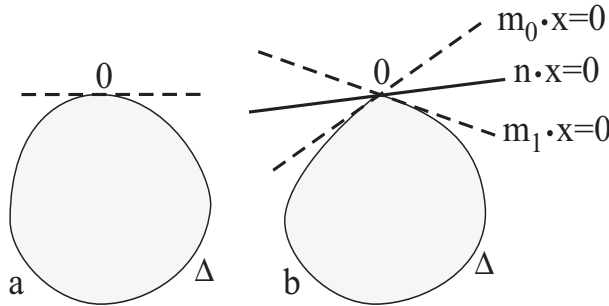

Fig. 10. The case in which some line of N^\perp does not intersect $\text{int } \Delta$

Combining Prop. 5.18 with Theorem 3, we obtain the following results:

THEOREM 4. *If $\mathcal{A} = \{A_i \mid i \in I\}$ is sharply nested and closed in \mathcal{K}^2 or \mathcal{K}_0^2 , $\cap A_i$ is a singleton and $\cup A_i$ is unbounded, then \mathcal{A}^T is Čebyšev.*

Proof: By Prop. 5.18 the minimum distance from any compact convex set X is attained by translates of at most one nest element. By Lemma 5.2, as the nest is closed, the minimum distance is attained; and by Theorem 3 it is attained exactly once. ■

The following result was proved in [6]:

PROPOSITION 5.19. *For every $A \in \mathcal{O}^d$, the family $\{A\}^T$ of all translates of A is Čebyšev in \mathcal{O}^d .*

Combining this with Proposition 5.18, we get:

THEOREM 5. *Suppose $\mathcal{A} = \{A_i \mid i \in I\}$ is sharply nested and closed in \mathcal{O}^2 or \mathcal{O}_0^2 . Then \mathcal{A}^T is Čebyšev.*

EXAMPLE 5.20. Families of homothets of smooth bodies are Čebyšev in \mathcal{K}_0^2 ; and families of the form $\{\lambda A + s \mid \lambda \in [0, \infty), s \in \mathbf{R}^2\}$, A smooth, are Čebyšev in \mathcal{K}^2 . Figure 11 shows that smoothness is essential; the triangles are homothetic but equidistant from the body X .

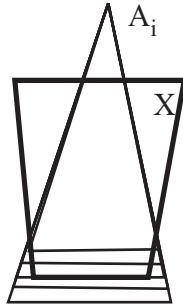

Fig. 11. A non-Čebyšev family of homothets

Note that both this example and the next one generalize the result [4, 5] that the family of balls is Čebyšev in \mathcal{K}_0^2 .

EXAMPLE 5.21. Families of translates of parallel bodies, of the form $\{(A)_d + s \mid d \in [0, \infty), s \in \mathbf{R}^2\}$ are Čebyšev in \mathcal{O}^2 . This does not hold in \mathcal{K}^2 (except for the special case in which A is a point and the other bodies are balls) because any other such family has a least element, so that Prop. 5.9 applies.

However, the result is “morally true” in \mathcal{K}^2 as well, and if we can extend the nest from A down to a point in an appropriate fashion, the translational closure of the resulting family is Čebyšev. For instance, if A is smooth,

$$\{\lambda A \mid \lambda \in [0, 1]\} \cup \{(A)_\lambda + s \mid \lambda \in [0, \infty), s \in \mathbf{R}^2\} \quad (40)$$

is Čebyšev in \mathcal{K}^2 .

EXAMPLE 5.22. For $I = [0, 1]$ or $[0, \infty)$, translational closures of affine segments and rays, of the form

$$\{C + \lambda D + x \mid \lambda \in I, x \in \mathbf{R}^2\}, \quad (41)$$

are Čebyšev in \mathcal{O}^2 provided that D is smooth. This generalizes both Example 5.20 and Example 5.21.

Theorem 5 applies to nests that may be bounded above or below (or both) in \mathcal{O}^2 , whereas the nest in Theorem 4 must contain arbitrarily large and small elements. It is natural to ask whether Prop. 5.10 could be used to obtain corresponding results in \mathcal{K}^2 for nests bounded above.

Recall that the “top” body A_1 in Prop. 5.10 is required to be strictly convex. In the context of that proposition, this implies nothing about the other bodies; but later results refer to *sharply* nested families, in which any A_i , $i < 1$, is a Minkowski summand of A_1 , thus strictly convex if A_1 is. Thus by requiring A_1 to be strictly convex we in fact force the entire nest to be so.

THEOREM 6. *If $\mathcal{A} = \{A_i \mid i \in I\}$ is a sharply nested closed arc of strictly convex sets in \mathcal{K}^2 or \mathcal{K}_0^2 , and $\cap A_i$ is a singleton, then \mathcal{A}^T is Čebyšev.*

EXAMPLE 5.23. In \mathcal{K}^2 , if C is smooth and strictly convex, the set

$$\{\lambda C + x \mid \lambda \in [0, 1], x \in \mathbf{R}^2\} \quad (42)$$

is Čebyšev. Again, in \mathcal{K}_0^2 ,

$$\{\lambda C + x \mid \lambda \in (0, 1], x \in \mathbf{R}^2\} \quad (43)$$

is Čebyšev. In particular, the set of all “small enough” balls (with radius less than some R) is Čebyšev in \mathcal{K}_0^2 , and in \mathcal{K}^2 with the addition of singletons.

OBSERVATION 5.24. In \mathcal{K}^d , $d > 2$, it is possible for the minimum distance from a body X to a family \mathcal{A}^T to be achieved at two translates equidistant from X ; see for instance Fig. 6 above. Moreover, it may be achieved by equidistant strictly convex bodies of different sizes, so Prop. 5.18, Theorem 5 and Theorem 6 do not generalize to higher dimensions either.

EXAMPLE 5.25. Consider the two bodies

$$P := \text{conv} \{(\pm 1, \pm 1, 0), (0, \pm 1, 1)\}$$

and

$$Q := \text{conv} \left\{ (\pm 1, \pm 1, 0), (\pm 1, 0, 1), \left(0, 0, -\frac{2 + 11\sqrt{2}}{20}\right) \right\}$$

(see Figure 12.)

We now define a family $\{A_i \mid 0 \leq i < \infty\}$ as follows.

$$A_i = \begin{cases} (10i)(P)_{1/10} & \text{if } 0 \leq i \leq 1/10; \\ (P)_i & \text{if } i \geq 1/10. \end{cases} \quad (44)$$

It may be verified that this family is sharply nested, and that for $\frac{1}{10} \leq i \leq (2 - \sqrt{2})/2$, bodies of the form $A_i + (0, 0, -\sqrt{2}i)$ are equidistant from Q (specifically at distance $1/\sqrt{2}$), while any other set of the form $A_i + x$ is more distant.

As every face is a triangle or a rectangle, hence cyclic, we may replace each of P and Q by the intersections of all balls of some large radius R containing the polyhedron. The resulting A_i are strictly convex and appropriate translates are again equidistant from Q .

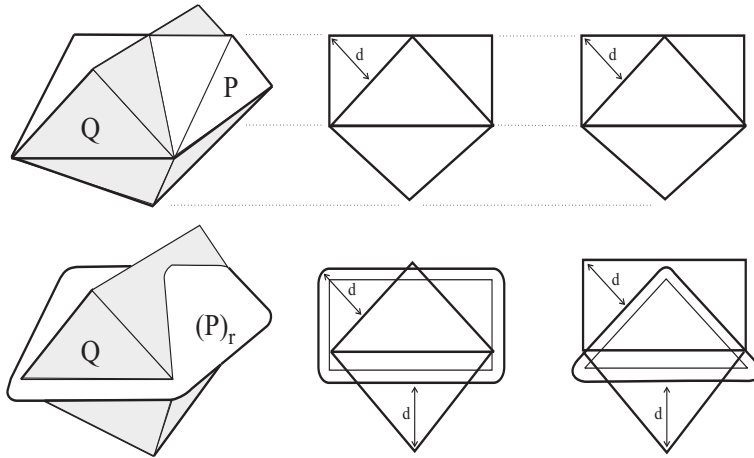

Fig. 12. A family of parallel bodies with non-Čebyšev translates

The family \mathcal{B}^d of all balls and singletons is an example of a translational closure of a nest in \mathcal{K}^d , $d > 2$, with the Čebyšev property. While at the moment no others are known, it seems likely that more exist. One plausible conjecture is that families such as that of Example 5.25 are fairly uncommon, and that \mathcal{A}^T is Čebyšev for almost all sharply nested families \mathcal{A} . On the other hand, it is also plausible that every body belongs to a sharply nested family \mathcal{A} for which \mathcal{A}^T is not Čebyšev.

6. General Minkowski spaces and Sim-invariant Čebyšev sets. In [3], various results from [4] and [6] were generalized to hyperspaces \mathcal{K}^B and \mathcal{O}^B over Minkowski spaces with unit ball B . Some classes of Čebyšev set, such as singletons $\{A\}$ and strongly nested sets, carried over in all cases; others, such as convex sets of singletons in \mathcal{K}^B and families of translates in \mathcal{O}^B , did so if and only if B was strictly convex.

As observed at the beginning of the previous section, no specific properties of the Euclidean ball apart from strict convexity were used in the proofs of Theorem 1 or Theorems 4–6. Thus, the Čebyšev sets constructed in this paper likewise have counterparts in any smooth and strictly convex Minkowski space of appropriate dimension. This permits us to answer a question of Bogdewicz and Moszyńska, who noted [4] that \mathcal{B}^n and \mathcal{K}_0^n were Sim-invariant Čebyšev sets in \mathcal{K}_0^n , while $[\mathbf{R}^n]$, $[\mathbf{R}^n] \cup \mathcal{B}^n$, and \mathcal{K}^n were Sim-invariant Čebyšev sets in \mathcal{K}^n . They asked whether other such sets exist. We answer this in the affirmative, for appropriate hyperspaces.

EXAMPLE 6.1. Let $B \subset \mathbf{R}^2$ be a strictly convex body, centrally symmetric but with no other linear automorphisms. Then Sim_B consists precisely of the automorphisms $x \mapsto \lambda x + t$ for $\lambda \neq 0$ and $t \in \mathbf{R}^2$. Let $Z \in \mathcal{K}^B$ be smooth, centrally symmetric, and not homothetic to B . As shown in Example 5.20), the family of homothets of Z is Čebyšev in \mathcal{K}_0^B , while $\{\lambda Z + t \mid \lambda \in [0, \infty), t \in \mathbf{R}^2\}$ is Čebyšev in \mathcal{K}^B .

Acknowledgements : The author would like to thank M. Moszyńska and the anonymous referee for helpful comments.

References

- [1] R. Arnold, *Zür L^2 -Bestapproximation eines konvexen Körpers durch einen bewegten konvexen Körper*, Mh. Math. 108 (1989), 277-293
- [2] I. Bárány, *On the minimal ring containing the boundary of a convex body*, Acta Sci. Math. 52 (1988) 93-100
- [3] A. Bogdewicz, R. Dawson, and M. Moszyńska, *Čebyšev sets in hyperspaces over a Minkowski space*, Glas. Mat., 42, No.1 (2007), 57-67
- [4] A. Bogdewicz and M. Moszyńska, *Čebyšev sets in the space of convex bodies*, Rend. Circ. Mat. Palermo (2), Suppl. 77 (2006), 19-39.
- [5] T. Bonnessen, *Über das isoperimetrische Defizit ebener Figuren*, Math. Ann. 91 (1924), 252-268.
- [6] R. Dawson and M. Moszyńska, *Čebyšev sets in hyperspaces*, Can. Jour. Math., to appear
- [7] R. Dawson, *On the mobility of bodies in \mathbf{R}^n* , Math. Proc. Camb. Phil. Soc. 98 (1985) 403-412
- [8] B. Gelbaum and J. Olmsted, *Counterexamples in Analysis*, Holden-Day, San Francisco, 1964
- [9] I. Herbut and M. Moszyńska, *Optimal isometries for a pair of compact convex subsets of \mathbf{R}^n* , this volume, pages ??-??
- [10] V. Klee, *Convexity of Čebyšev sets*, Math. Ann. 142 (1961), 292-304.
- [11] M. Moszyńska, *Selected Topics in Convex Geometry*, Birkhäuser, Boston, 2006.